

Karakteristike



- Energetsko varna zračna zavesa s toplotno črpalko: Do 70% zmanjšanje stroškov in emisij CO2 (način ogrevanja).
- Posebej zasnovana za namestitev kjer je potrebno telo arhitekturne zaveses vgraditi v stolpec ali pregrado zaradi arhitekturnih razlogov.
- Samonosilna konstrukcija ohišja iz pocinkane jeklene plošče, izdelano v strukturni epoksi-poliestrski barvi standardno bele barve RAL9016. Druge barve ali nerjavne jeklo so na voljo po zahtevi.
- Pretok zraka Invisair sledi ravni liniji od rešetke za dovod zraka do odvoda. Dovodno območje znotraj pregrade ali stebra mora biti oblikovano z ustrezno rešetko, ki jo zagotavljajo drugi.
- Anodizirani aluminijasti odhondni ventili oblikovani z zračnim profilom, nastavljivi od 0 do 15 ° na vsaki strani.
- Centrifugalni ventilatorji z dvojnimi dovodi, ki jih poganja zunanji rotor motorja z nizko raven hrupa. Izbira med 5 hitrostmi. Modeli EC so sestavljeni z ventilatorji z visoko učinkovitostjo in majhno porabo.
- Vključuje samo ogrevanje direktne ekspanzijske tuljave z vgrajenimi temperaturnimi senzorji.
- Plug&Play nadzorna plošča CS-5DX-NE slave DX z izbirnikom 5 hitrosti in 7m telefonskim kablom.
- DX 1:1:  
Pripravljeno za priključitev na zunanjo toplotno črpalko DAIKIN Inverter (R410A) in ekspanzijski ventil ni vključen, naročnik ga mora kupiti sam. Zahteva DAIKIN DX Interface KIT, prilagojen za zračno zaveso in programabilno krmiljenje.
- DX VRV:  
Pripravljeno za priključitev na zunanjo toplotno črpalko DAIKIN VRV (R410A) in ekspanzijski ventil ni vključen, naročnik ga mora kupiti sam. Zahteva DAIKIN VRV Interface KIT, prilagojen za zračno zaveso in programabilno krmiljenje.

Specifikacije

50Hz

Model	Nominalni pretok zraka (m³/h)	Toplotna črpalka - DX 1:1			
		Priporočena višina instalacije (m)	Zunanja enota 230Vx1	Zunanja enota 400Vx3	
IECG 1500 DX13-DA	2920	3-4,2	ERQ 100 AV1	-	5/8" - 3/8"
IECG 1500 DX15-DA	2920	3-4,2	ERQ 125 AV1	ERQ 125 AW1	5/8" - 3/8"
IECG 2000 DX24-DA	4380	3-4,2	-	ERQ 200 AW1	3/4" - 3/8"
IECG 2500 DX25-DA	5110	3-4,2	-	ERQ 200 AW1	3/4" - 3/8"
IECG 2500 DX29-DA	5110	3-4,2	-	ERQ 250 AW1	7/8" - 3/8"

Model	Nominalni pretok zraka (m³/h)	Toplotna črpalka - VRV	
		Priporočena višina instalacije (m)	
IECG 1500 VRV13-DA	2920	3-4,2	5/8" - 3/8"
IECG 1500 VRV15-DA	2920	3-4,2	5/8" - 3/8"
IECG 2000 VRV20-DA	4380	3-4,2	3/4" - 3/8"
IECG 2000 VRV24-DA	4380	3-4,2	3/4" - 3/8"
IECG 2500 VRV25-DA	5110	3-4,2	3/4" - 3/8"
IECG 2500 VRV29-DA	5110	3-4,2	7/8" - 3/8"

60Hz

Model	Nominalni pretok zraka (m³/h)	Toplotna črpalka - DX 1:1		
		Priporočena višina instalacije (m)	Zunanja enota 230Vx1	Zunanja enota 400Vx3



IECG 1500 DX13-DA	2920	3-4,2	ERQ 100 AV1	-	5/8" - 3/8"
IECG 1500 DX15-DA	2920	3-4,2	ERQ 125 AV1	ERQ 125 AW1	5/8" - 3/8"
IECG 2000 DX24-DA	4380	3-4,2	-	ERQ 200 AW1	3/4" - 3/8"
IECG 2500 DX25-DA	5110	3-4,2	-	ERQ 200 AW1	3/4" - 3/8"
IECG 2500 DX29-DA	5110	3-4,2	-	ERQ 250 AW1	7/8" - 3/8"

Toplotna pumpe - VRV

Model	Nominalni pretok zraka (m³/h)	Preporučena višina instalacije (m)
IECG 1500 VRV13-DA	2920	3-4,2
IECG 1500 VRV15-DA	2920	3-4,2
IECG 2000 VRV20-DA	4380	3-4,2
IECG 2000 VRV24-DA	4380	3-4,2
IECG 2500 VRV25-DA	5110	3-4,2
IECG 2500 VRV29-DA	5110	3-4,2

Dimenzije

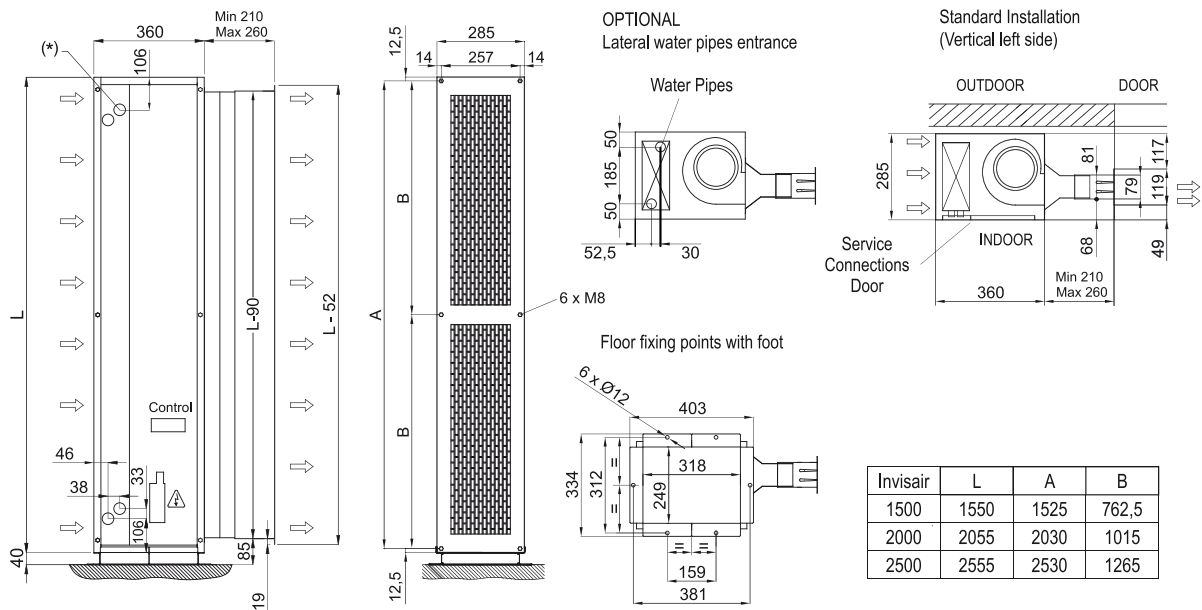

Invisair	L	A	B
1500	1550	1525	762,5
2000	2055	2030	1015
2500	2555	2530	1265